

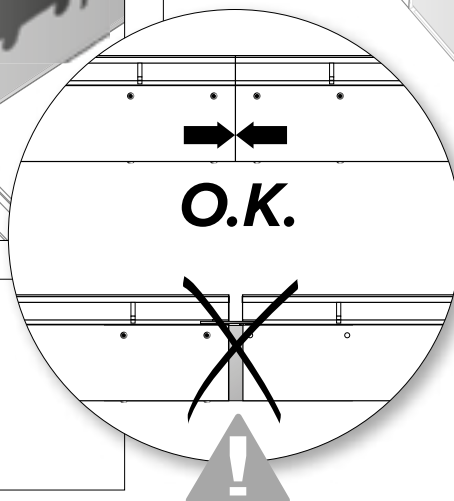

MINI CANAL

Installation manual for continuous trenches

Energy
SAVERS
LOW-H₂O

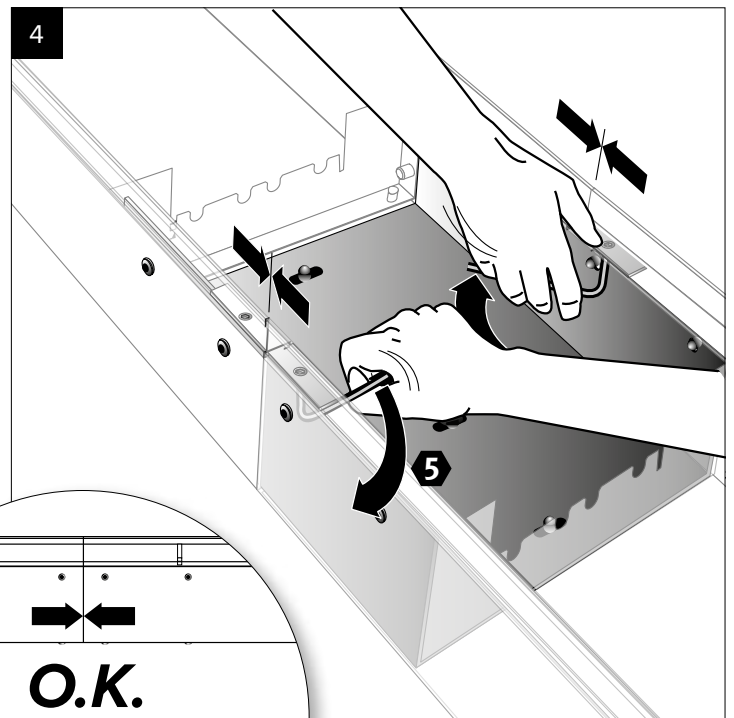
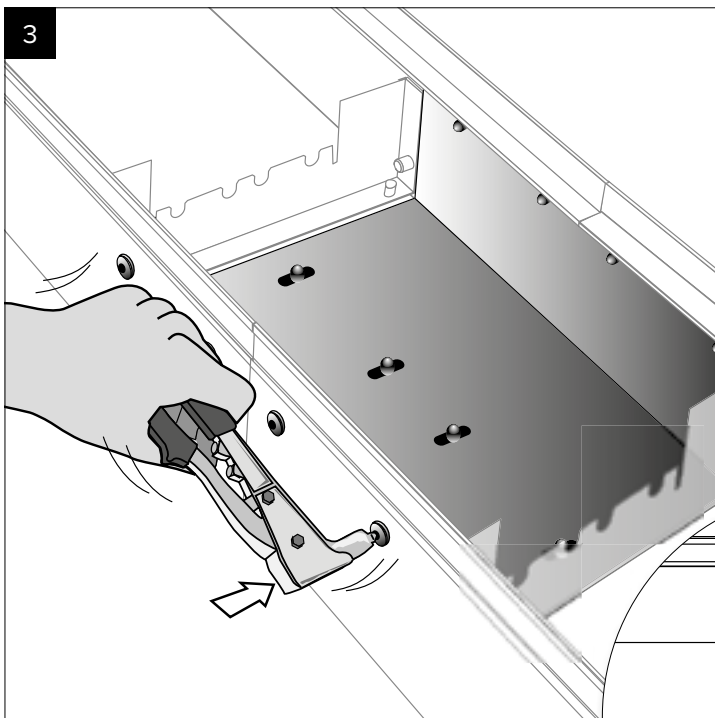
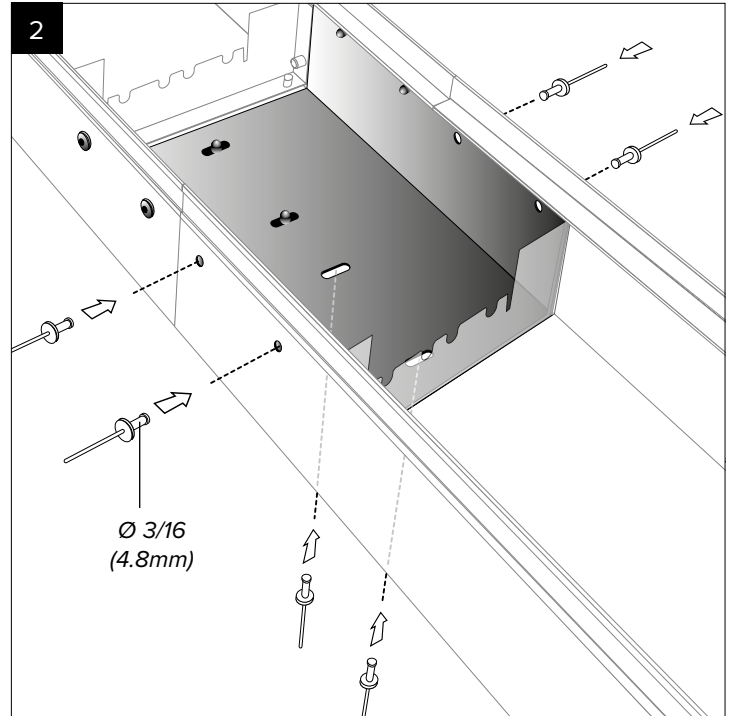
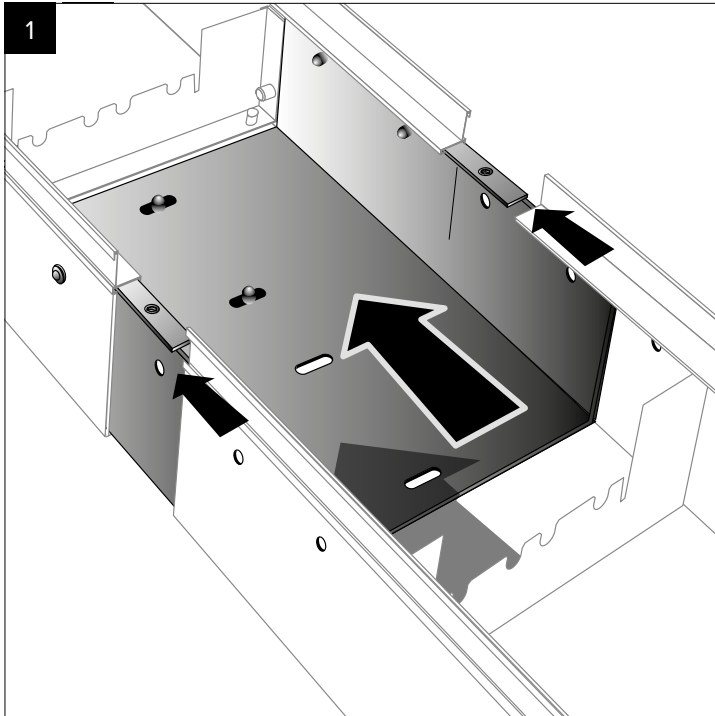

Parts

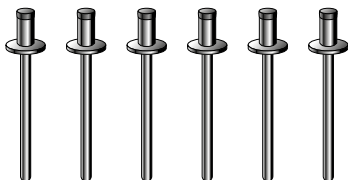



MINI CANAL

Installation manual for corner connections

Energy
SAVERS
LOW-H₂O

Parts

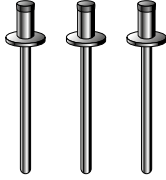

Ø 3/16
(4.8mm)

